







Tolerances Expansion Bolt:

Form	 H8	Circularity
	 H8	Cylindricity
Orientation	 H8	Parallelism
	 H8	Perpendicularity
Location	 H8	Position
	 H8	Concentricity

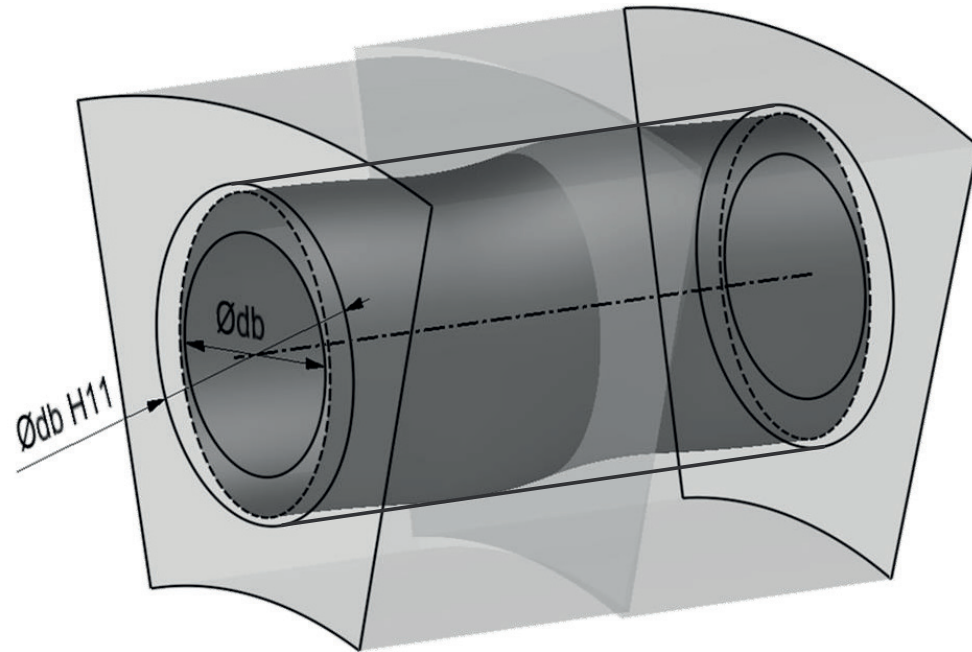

The sum of all tolerances must be smaller than H11; i.e. the bores must lie between 2 concentric cylinders with diameters Ødb and Ødb H11 .
If the bores are outside the tolerance, it is advisable to drill them out together to a uniform dimension, which is then within the tolerance H8 over the entire length of the bore.